WATER HARVESTING AND AQUACULTURE
FOR RURAL DEVELOPMENT

TRANSPORTING FISH



INTERNATIONAL CENTER FOR AQUACULTURE
AND AQUATIC ENVIRONMENTS
AUBURN UNIVERSITY

INTRODUCTION

Transporting fish is a very important part of fish culture. Fry and fingerlings must be transported from hatchery to pond for stocking. Brood fish are sometimes transported into the hatchery to spawn. It may even be necessary to transport live harvested fish to the market for sale. Many methods for fish transport have been developed. Several of these methods are described here.

Fish are generally transported in containers such as cans of different sizes, pots of ceramic or metal, wooden or metal buckets, vats, barrels, plastic bags, styrofoam boxes, bottles, jugs, animal skins and bamboo sections. In fact, almost any clean, waterproof container may be used. Certain containers provide good insulation from heat, for example, wood or styrofoam. Containers like metal or plastic are poor insulators and may have to be wrapped with wet towels or packed with ice to keep temperatures down.

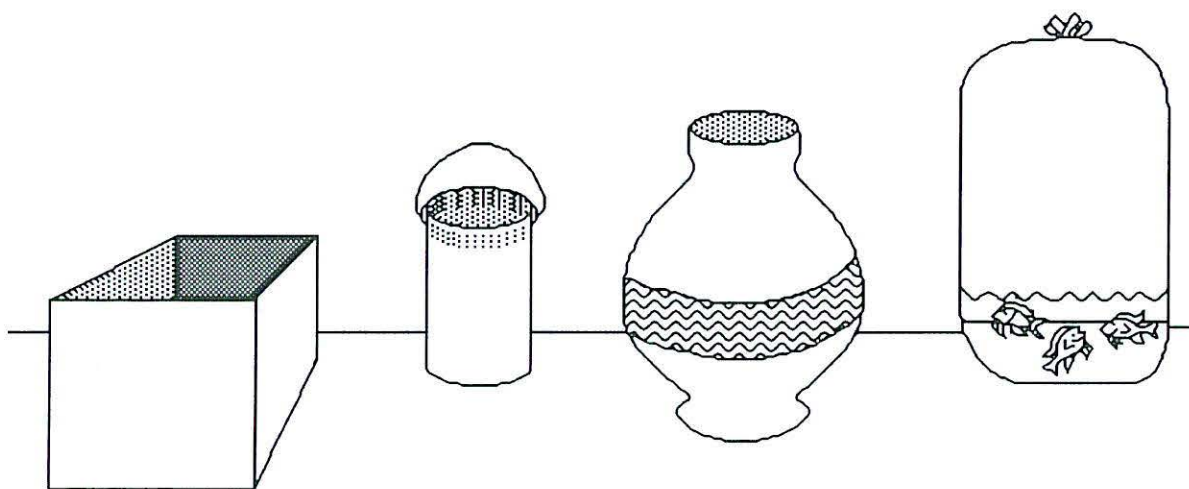

Figure 1: Various containers are used to transport fish.

Once fish have been placed in their transport container they are brought to their destination by the quickest possible means that will provide a relatively smooth and direct route. This may be by foot, animal cart, bicycle, boat, motorized land vehicle, train or plane.

CONSIDERATIONS FOR FISH TRANSPORT

Fish transport must be done carefully in order to be successful. A poorly organized effort may easily result in death of fish. The following factors directly influence fish transport.

Tolerance to transport.

A famous saying in fish culture is that "fish are not potatoes". They need tender loving care if they are to remain strong and healthy. Tolerance of fish to transport is related to their ability to resist or adapt to stressful conditions. Their resistance also changes as they pass through various life stages. Larvae are very delicate as are brood fish which are ready to lay eggs. The table below indicates stress tolerance levels of some commonly cultured fish.

| | |
|--------------|--------------------|
| oreochromis | - high tolerance |
| catfish | - high tolerance |
| gourami | - high tolerance |
| carps: | |
| common | - high tolerance |
| bighead | - medium tolerance |
| grass | - medium tolerance |
| silver | - low tolerance |
| mud | - high tolerance |
| black | - high tolerance |
| Indian carps | - medium tolerance |

Presence of food in the intestines.

Fish survive transport better if they have no food in their intestines. For this reason, they are not fed for 1 to 2 full days prior to the time they will be transported. Brood stock are often conditioned for transport to spawning facilities by crowding them up in a seine net and releasing them. This procedure is done for 2 consecutive days before moving them from their pond to the hatchery for spawning. The fish stop eating and this helps them adapt to the stress of artificial spawning.

Fish can also be harvested and held in net enclosures or tanks for 24 to 48 hours with clean, preferably gently running, water. The fish pass food out of their intestines and will be in good condition for transport. If the fish have disease or parasites they can also be treated easily in tanks prior to transport.

Age and size of fish.

A lower weight of small fish can be transported per unit volume of water than large fish. This guide classifies fish broadly into four main groups according to what life cycle stage they are in. Newly hatched fish are called larvae or sac fry. They are slow-moving and possess a yolk sac which provides them with at least a 24 hour food supply after hatching.

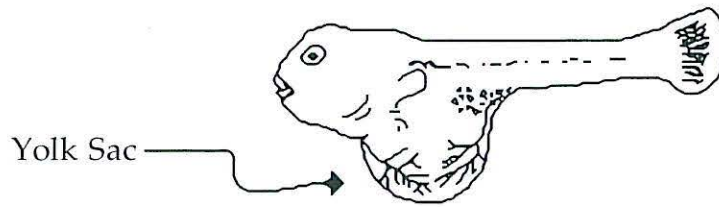

Figure 2: A sac fry with yolk sac.

Post larvae do not have a yolk sac and are commonly called fry. Fry weigh less than 1 g. A 3 to 4 week old fish weighing more than 1 g may be called a fingerling. Sexually mature fish are often called brood stock. Table 1 provides a "rule-of-thumb" guide to determine how many fish of a given age group may be transported. These figures are based on transporting fish in sealed plastic bags containing oxygen and about 8 liters of clean water at approximately 18°C. These numbers are only a rough guide and may not work under all conditions or for all kinds of fish. Tanks or containers must be used to transport fish if plastic bags are not available. Table 2 gives recommendations for transporting different sized fish in tanks with diffused oxygen at approximately 18°C.

Table 1: Quantities of different sized fish that can be transported in sealed plastic bags (18 inch x 32 inch) with approximately 7.6 liters of water and pure oxygen.

| <u>Fish Size</u> | <u>Duration of Transport</u> | | | |
|---------------------------------------|------------------------------|--------------|--------------|--------------|
| | <u>1 HR</u> | <u>12 HR</u> | <u>24 HR</u> | <u>48 HR</u> |
| Newly Hatched Larvae (grams/l) | 120 | 80 | 40 | 10 |
| 1/4 inch (0.64 cm) Fry (grams/l) | 60 | 50 | 40 | 20 |
| 1 inch (2.54 cm) Fingerling (grams/l) | 120 | 100 | 75 | 40 |
| 2 inch (5.08 cm) Fingerling (grams/l) | 120 | 105 | 90 | 40 |
| 3 inch (7.62 cm) Fingerling (grams/l) | 120 | 105 | 90 | 40 |
| Larger Fish (grams/l) | 480 | 180 | 120 | 60 |

Table 2: The weight of fish in grams per liter of water transported in tanks with diffused oxygen.

| <u>Fish Size</u> | <u>Duration of Transport</u> | | | |
|-------------------|------------------------------|-------------|--------------|--------------|
| | <u>1 HR</u> | <u>6 HR</u> | <u>12 HR</u> | <u>24 HR</u> |
| Larvae and Fry | NR* | NR* | NR* | NR* |
| 1 inch Fingerling | 120 | 60 | 30 | 30 |
| 2 inch Fingerling | 240 | 180 | 120 | 120 |
| 3 inch Fingerling | 360 | 240 | 120 | 120 |
| 8 inch Fingerling | 360 | 360 | 240 | 180 |
| Larger Fish | 480 | 480 | 360 | 240 |

* NR = Not Recommended

Methods used for transporting fish.

It is essential to maintain adequate oxygen in the water while transporting fish. The technique recommended for oxygenating water during fish transport is use of pure bottled oxygen. It may be bubbled continuously into an unsealed container during transport, or injected into a plastic bag containing water and fish which is then sealed air-tight for transport.

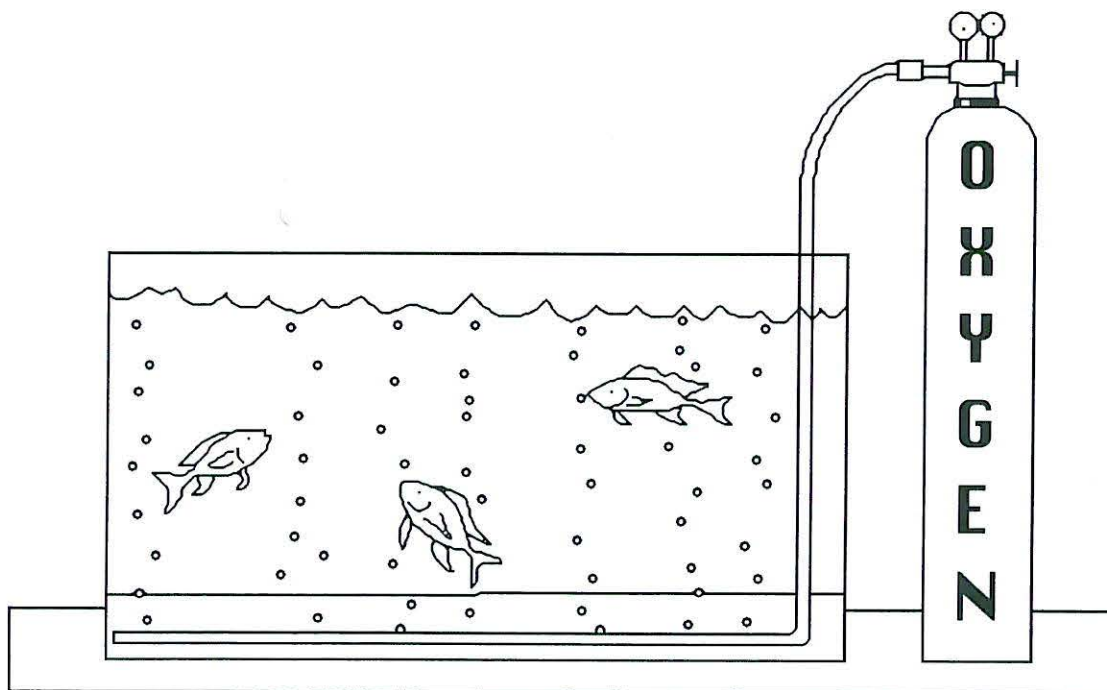

Figure 3: Continuous oxygen flow.

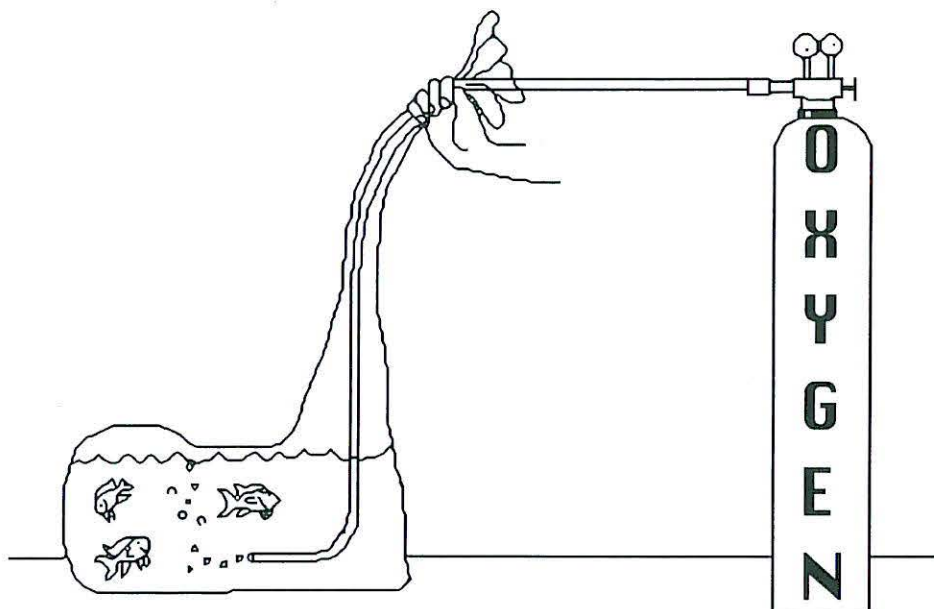

Figure 4: Oxygen sealed in a plastic bag.

When plastic bags are used, oxygen is added after water and fish. One-fourth of the bag usually contains water and fish and three-fourths contains oxygen. After adding oxygen the bag is sealed shut with a twisted rubber band, string or other material. As a precaution against leakage, the first plastic bag should be placed inside a second bag whenever possible. The sealed double bag of fish is then placed in a box, woven grass bag or other container for added protection and loaded onto a vehicle for transport. If properly packaged and insulated from heat, these containers can transport fish for 24 to 48 hours without water exchange. The following figures illustrate the use of plastic bags and bottled oxygen in fish transport.

Making and using plastic bags:

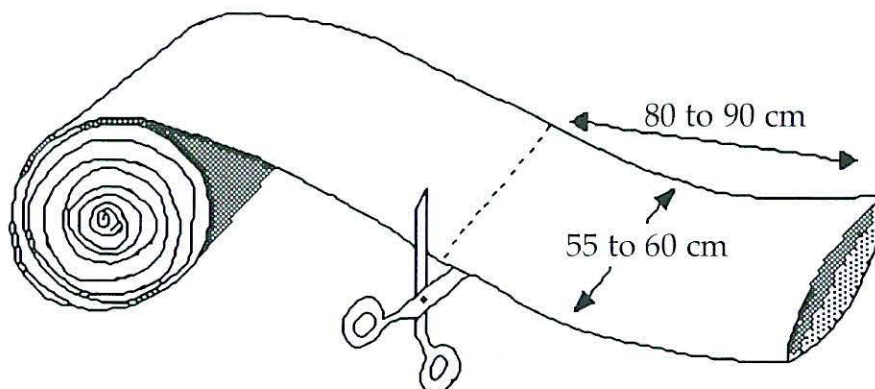

Figure 5: Cut the plastic bag material to the dimensions shown.

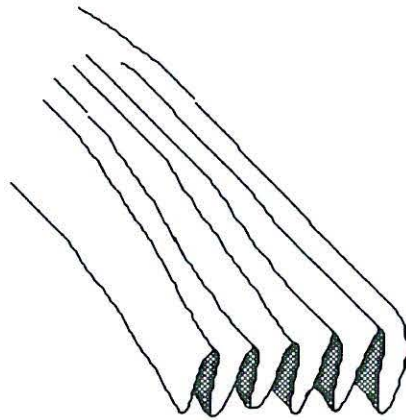

Figure 6: Fold one end.

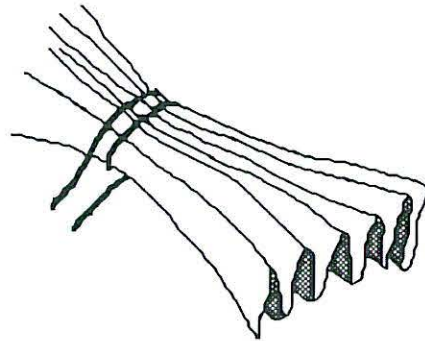

Figure 7: Tie it.

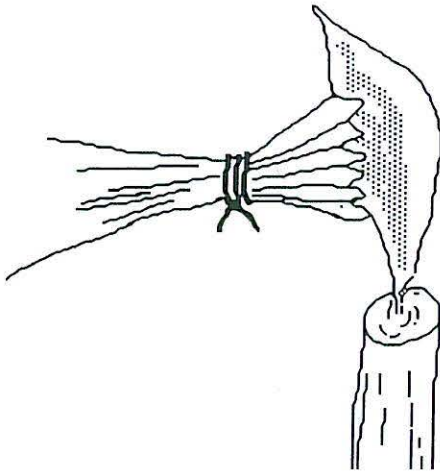

Figure 8: Melt and fuse the tied end.

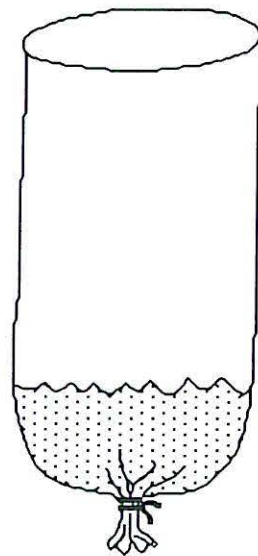

Figure 9: Fill 1/4 with water to check for leakage.

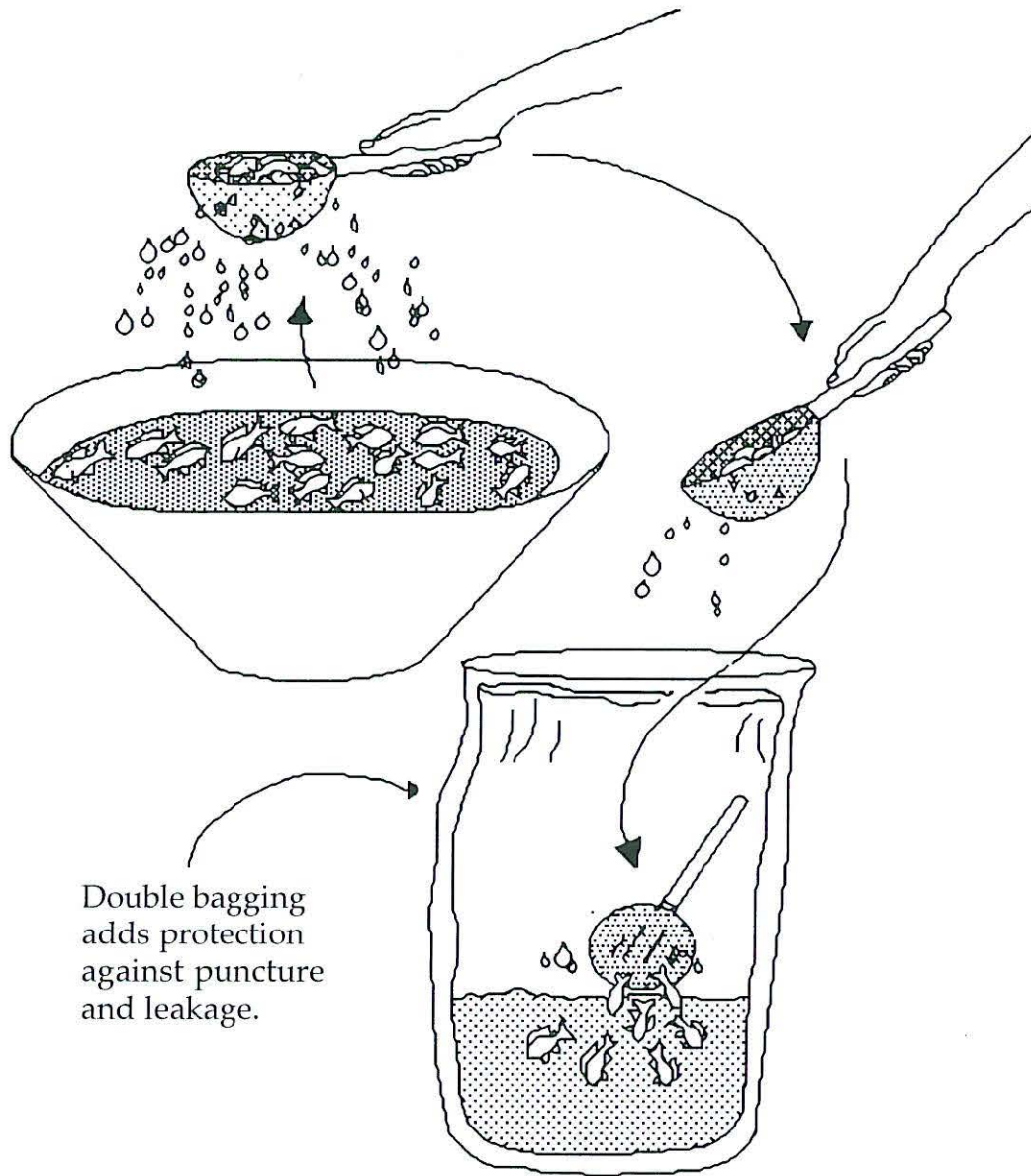

Figure 10: Counting fish for transport:

- a. Count the number of fish in 4 or 5 scoops.
- b. Divide the number of fish by the number of scoops to get the average number of fish per scoop.
- c. Estimate the number of fish needed for stocking a pond, cage, rice paddy or transport container.
- d. Divide c by b to get the number of scoops needed.
- e. A predetermined weight or number of fish is placed in plastic bags.

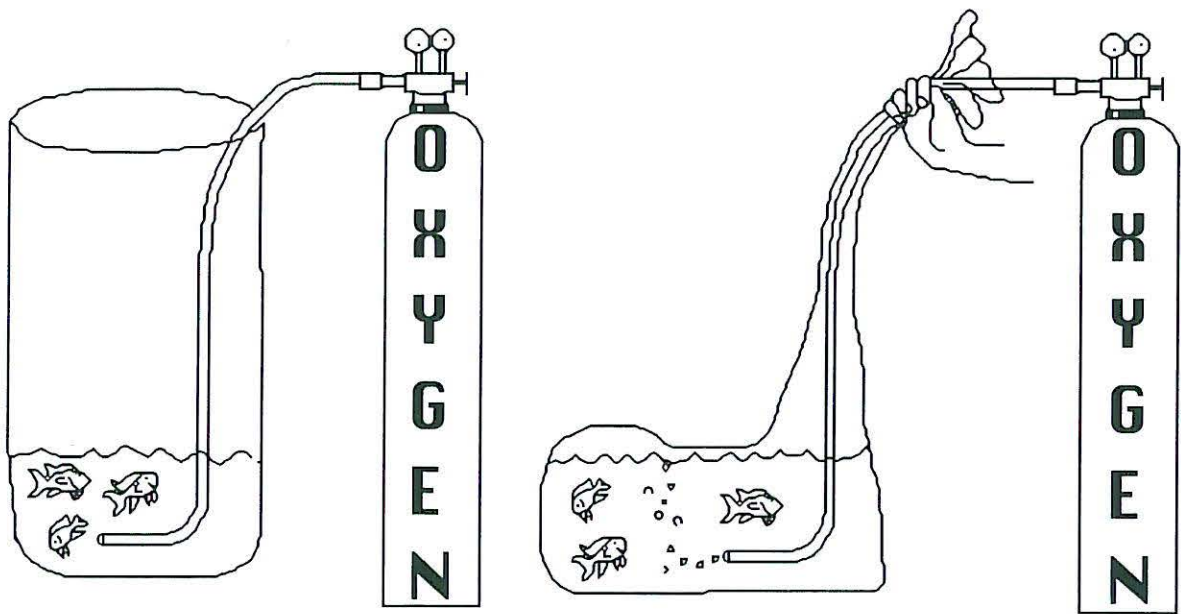

Figure 11: Insert oxygen hose into bag, depress bag to force out atmospheric air and slowly bubble pure oxygen through the water.

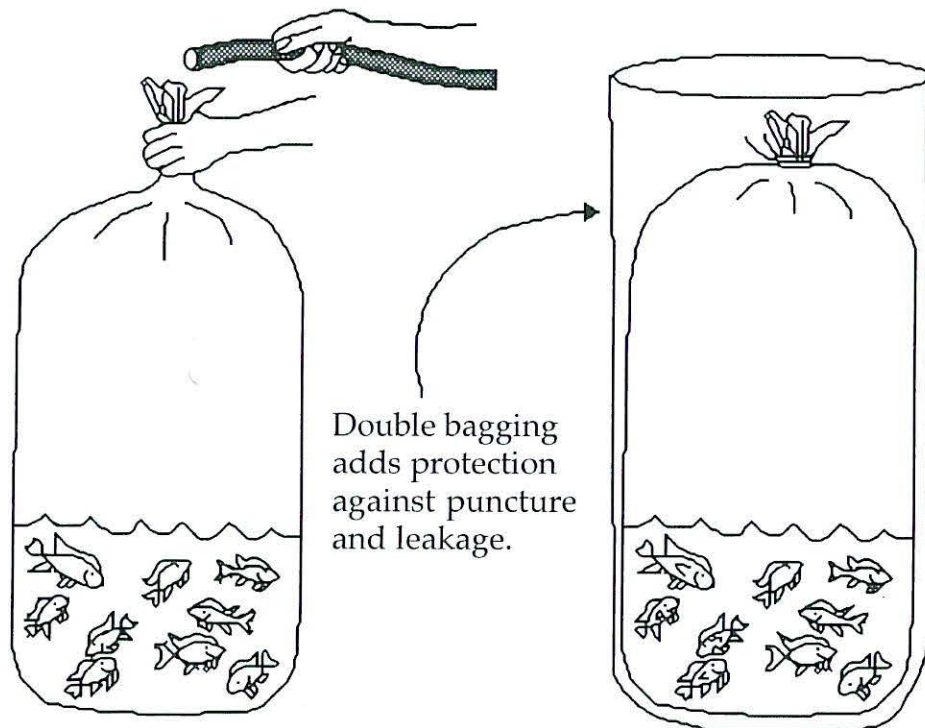
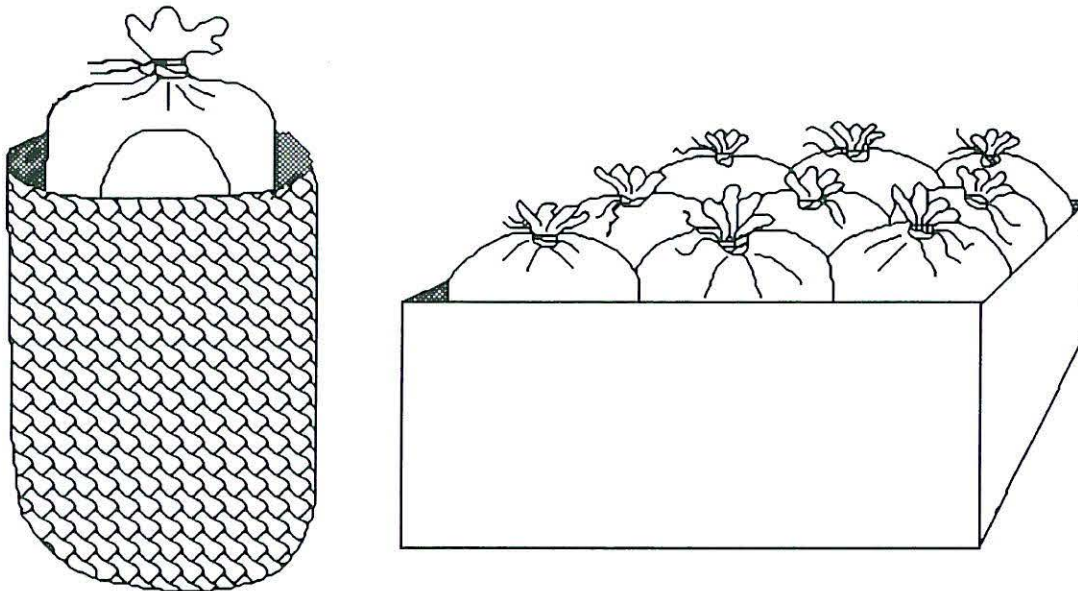

Figure 12: Squeeze bag closed while removing oxygen hose, and tie bag securely.



Wet cloths placed over the bags will keep them cool. Ice may be placed on top of the bags in hot weather. Some form of shade should also be provided. Cut banana or coconut leaves are commonly used.

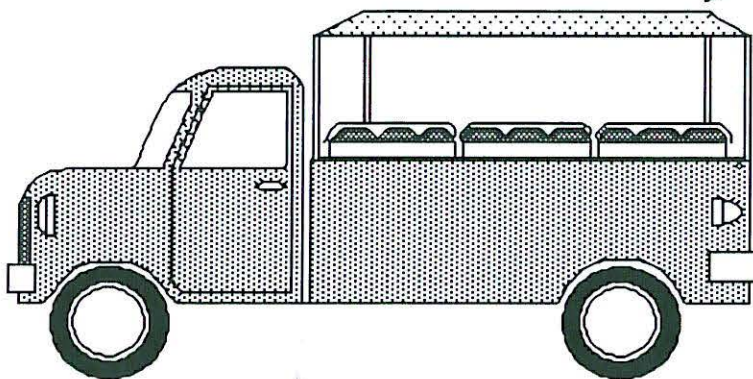

Figure 13: Place sealed bags into woven grass sacs, cardboard, wood or styrofoam boxes for protection during transport.

Changing water partially or completely.

Other procedures may be used in emergencies when bottled oxygen is unavailable. During hot weather or long trips, fish may rise to the surface and start gasping for air. This means oxygen in the water has been depleted and the water should be changed.

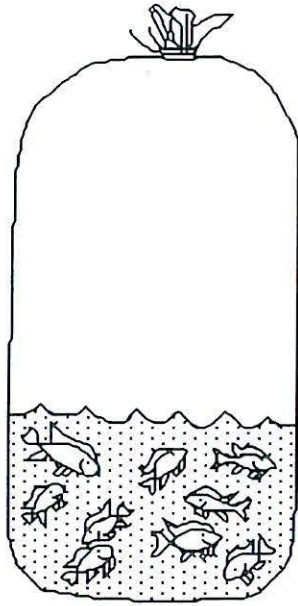

Figure 14: Adequate oxygen

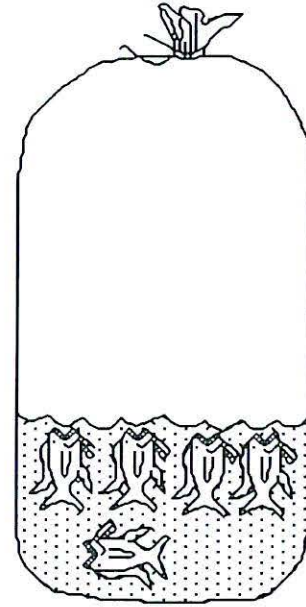

Figure 15 Depleted oxygen

When adding fresh water to a container of fish or when transferring fish into fresh receiving water, exercise the following precautions.

1. The new water should be clean, not muddy, and should be free of chemical pollutants. Avoid acidic or "peaty" water. Water from clean, clear-running springs or streams is best.
2. Poorly aerated water from wells, storage vats or reservoirs should be avoided because it is low in oxygen.
3. New water should be the same temperature as the original water.

To change water, empty half of the old water from the transport container and then refill with new water of the same temperature. This is easily done if the container has a screened drainage spout or overflow. Plastic bags are squeezed around the neck and tilted to allow water but not fish to escape. Siphon tubes are used to remove dirt and fish waste from the bottom of the transport container. DO NOT add new water quickly into the container. This may injure fish. Add it carefully. After 10 minutes change all of the water. Several exchanges may be necessary.

The temperature of new water should not differ from that of the transport water by more than 3 degrees centigrade. If it does, replace only one fourth of the old water initially and wait 10 minutes. Then replace one fourth of the water again and wait 10 minutes before completely changing the water.

Transport water can be aerated by agitation or air can be pumped into it during emergencies when water exchange is impossible and fish are clearly under stress. Agitation can be done in several ways. A small quantity of the old water can be removed and poured repeatedly from a height of 30 to 50 cm through a screen, grate or porous cloth back into the transport container. A person can also stick his hand into the water submerged up to the knuckles with fingers spread, and briskly wave back and forth. Electrical devices are also used for agitation.

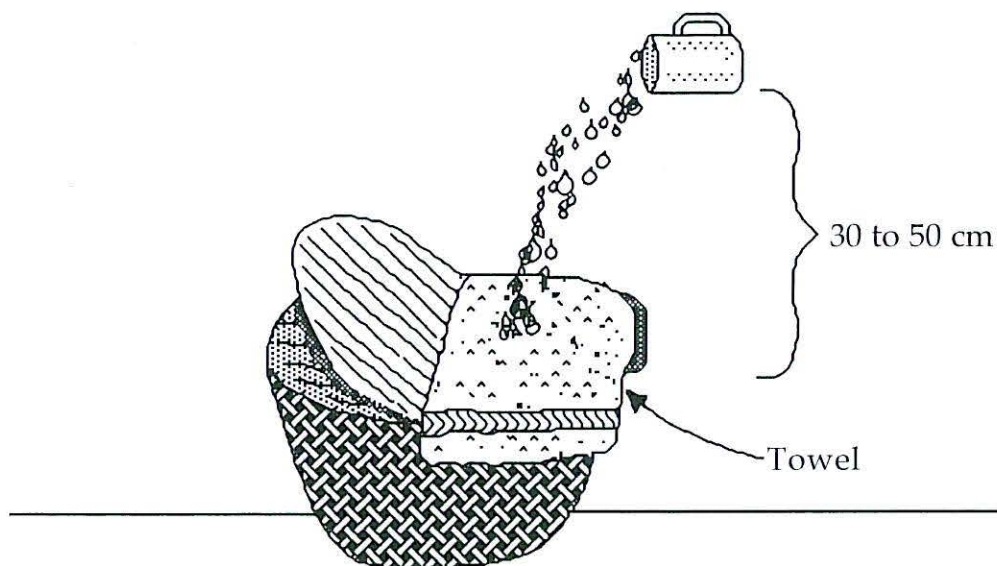

Figure 16: Pouring old water back into the transport container.

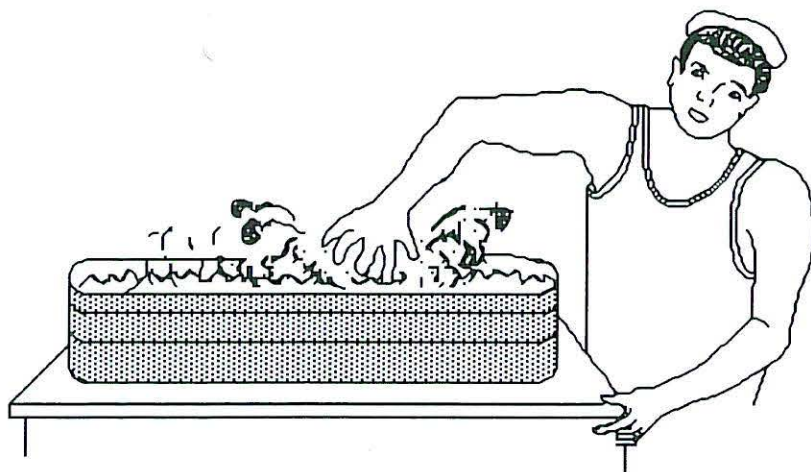

Figure 17: Aerating a container by hand.

Pumping air into the transport water can be done continuously from the start of travel or as an emergency measure. The finest air bubbles possible should be pumped into the water. Oxygen diffuses faster through fine bubbles. Large bubbles forcefully pumped into the water may also injure fish. Equipment which can be used includes bicycle tire pumps, battery operated aerators from aquarium shops, air filled inner tubes with air being squeezed through a regulated nozzle and any other locally built device.

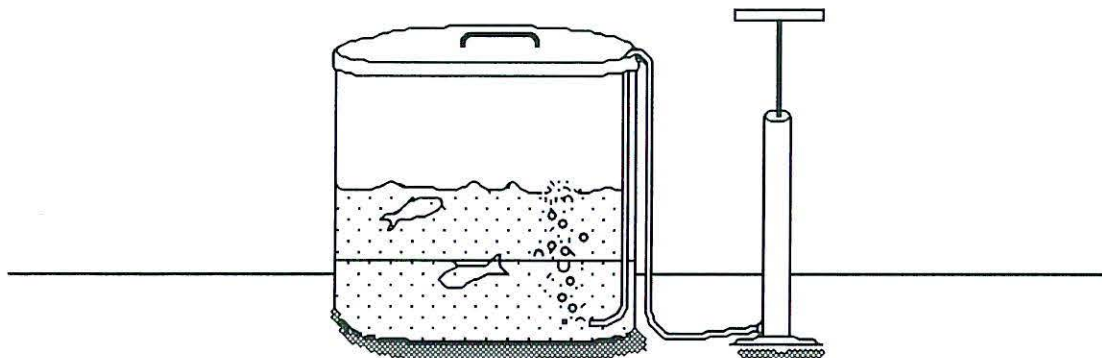

Figure 18: Pumping air into a transport container.

Agitation can be done simultaneously with aeration. However, these are only temporary measures and will not keep the fish alive very long. They may be tried until the water can be exchanged. DO NOT bubble your breath through the water. It contains carbon dioxide, not oxygen. You will only hasten the death of your fish by doing this.

USE OF HYDROGEN PEROXIDE AS AN OXYGEN SOURCE

Large capital outlay is required for tanks and other specialized equipment used in fish transport with pure bottled oxygen. A practical method for hydrogen peroxide use in fingerling transport has been developed by N. Innes Taylor and L.G. Ross at the Institute of Aquaculture, University of Stirling, Stirling FK9 4LA (Great Britain). Hydrogen peroxide decomposes to yield oxygen and water. It is available from pharmacies in most countries. Though expensive, it does not require a large capital outlay if small quantities of fish are being transported. The system is described below.

- 1) Dip a 2-l capacity (26 cm x 26 cm) plastic bag in clean water several times to get it wet. Then, shake it to remove excess water.
- 2) Place 1 g of fish liver in the bag.
- 3) Crush the liver by hand.
- 4) Add 40 ml of 6% weight per volume hydrogen peroxide.
- 5) Expel all air from the bag, and seal it with an elastic band.
- 6) Shake the bag to facilitate oxygen release. The bag should fill with oxygen in approximately 5 minutes.
- 7) Oxygen is squeezed into a transport bag containing water and fish through a plastic tube, as the following diagram shows. Liquid in the oxygen bag may kill fish and should not be squeezed into the transport bag. A pump is used to fill the transport bag completely.

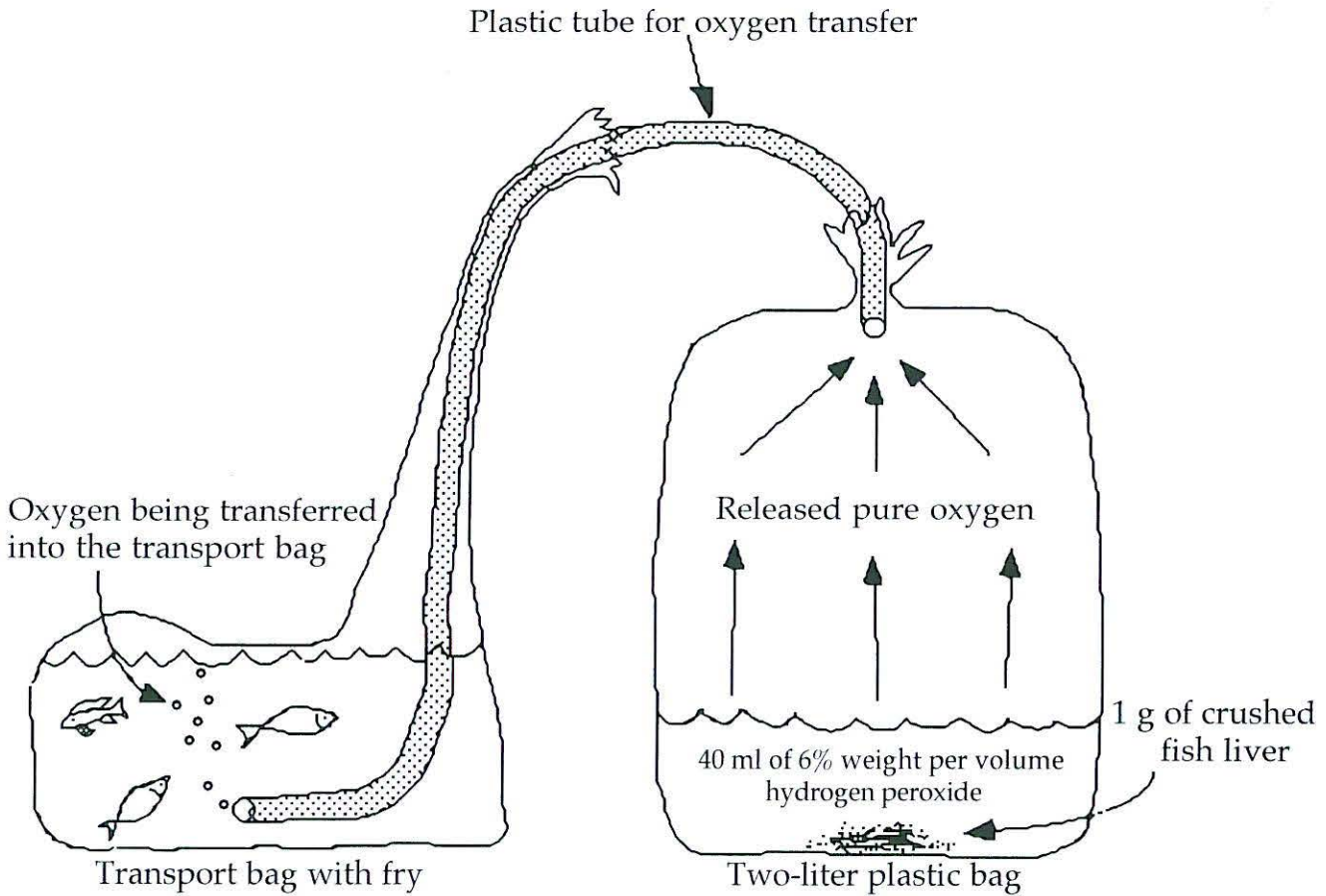

Figure 19: Producing pure oxygen from hydrogen peroxide for fish transport.

Temperature of transport water.

Water temperatures ranging from 18 to 28 degrees centigrade are suitable for transporting warm-water fish. The ideal temperature is 21 to 25 degrees centigrade.

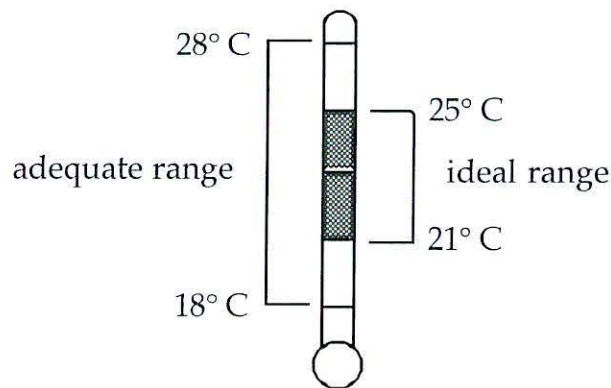

Figure 20: Temperature range for transporting warm-water fish.

Warm water holds less oxygen than cool water. Respiratory requirements of fish are also greater at higher temperatures. Thus, fewer fish can be transported per unit volume of warm water. The GOLDEN RULE of fish transport is to always maintain sufficient oxygen in the transport water. This can be done in several ways.

Keep transport containers cool. They should always be kept shaded and out of direct sunlight. As water warms it holds less oxygen, so prevent rapid warming of the transport containers. Ice may be packed around containers on long trips. DO NOT add ice directly to the water containing the fish. A wet cloth may also be wrapped around containers to reduce temperature by evaporative cooling if ice is not available. Be careful to prevent water temperature in the transport container from dropping below 18° C when using ice.

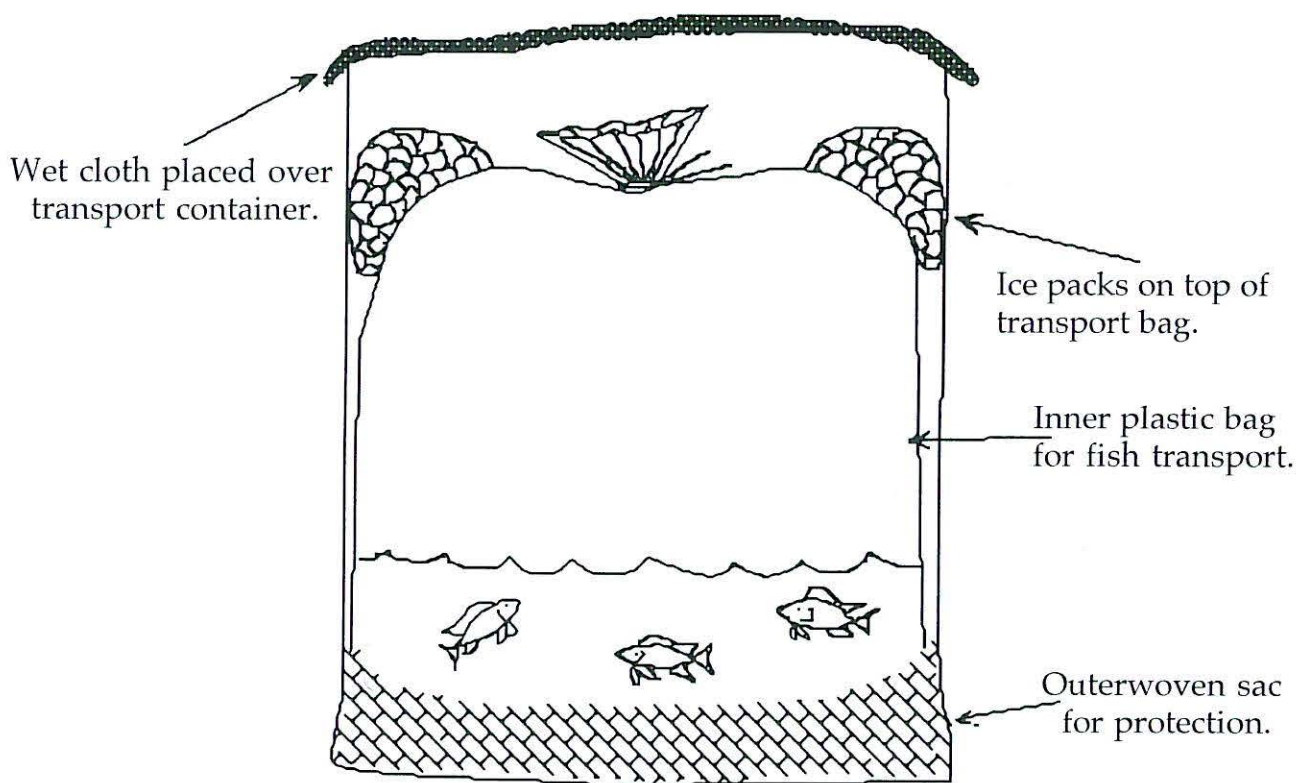

Figure 21: Packing ice around a plastic bag used for fish transport.

Duration of transport.

More fish can be transported per unit volume of water if the duration of transport is short. Fewer fish can be transported on long trips.

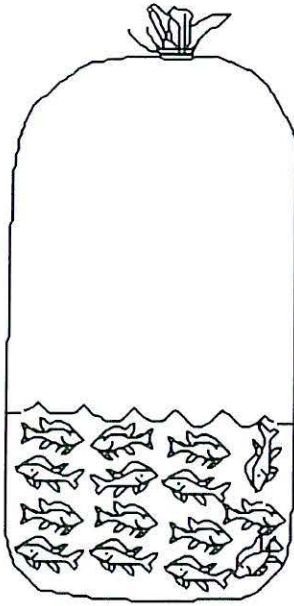

Figure 22: Short trip.

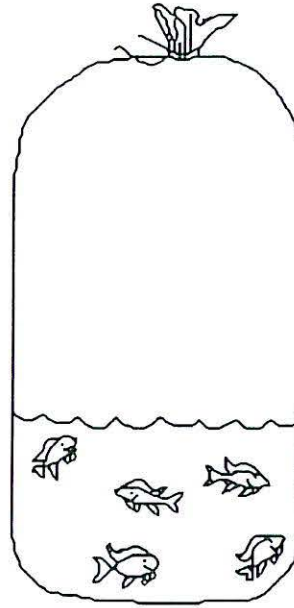

Figure 23: Long trip.

Mode of transport.

Use the fastest, smoothest and most direct means of transport possible. Some bumping and surging is useful in agitating water in containers. However, a rough ride with long stops greatly decreases the ability of fish to survive transport. Good communications cannot be overemphasized in planning fish transport.

Climatic conditions.

Fish should be transported during the coolest part of the day or at night in hot weather.

STOCKING PROCEDURES

Stocking your fish into their new home after transport can be the most critical aspect of the transport procedure. Temperatures of the transport water and water where the fish are to be stocked must be equalized before stocking the fish. This usually requires 15 to 30 minutes. A temperature difference no greater than 3 degrees centigrade is tolerable. When fish arrive at their destination, the special procedures used to change water during transport must be followed to acclimate them to the new water. This allows water temperatures in the transport container to equalize with the new water, and allows fish to adjust to changes in ionic quality of the new water.

Plastic bags should be floated on the water surface where the fish are to be released while the water exchange and acclimation procedure is done. Fish are then allowed to swim out of the bags into their new surroundings. Fish transported in containers which can not be set into the new water may be transferred with a soft net, or dipped out with a scoop or bucket. DO NOT pour fish from any height into their new environment. They will be weak after transport and can easily be injured by rough handling at this stage. Allow them to swim slowly into new water.

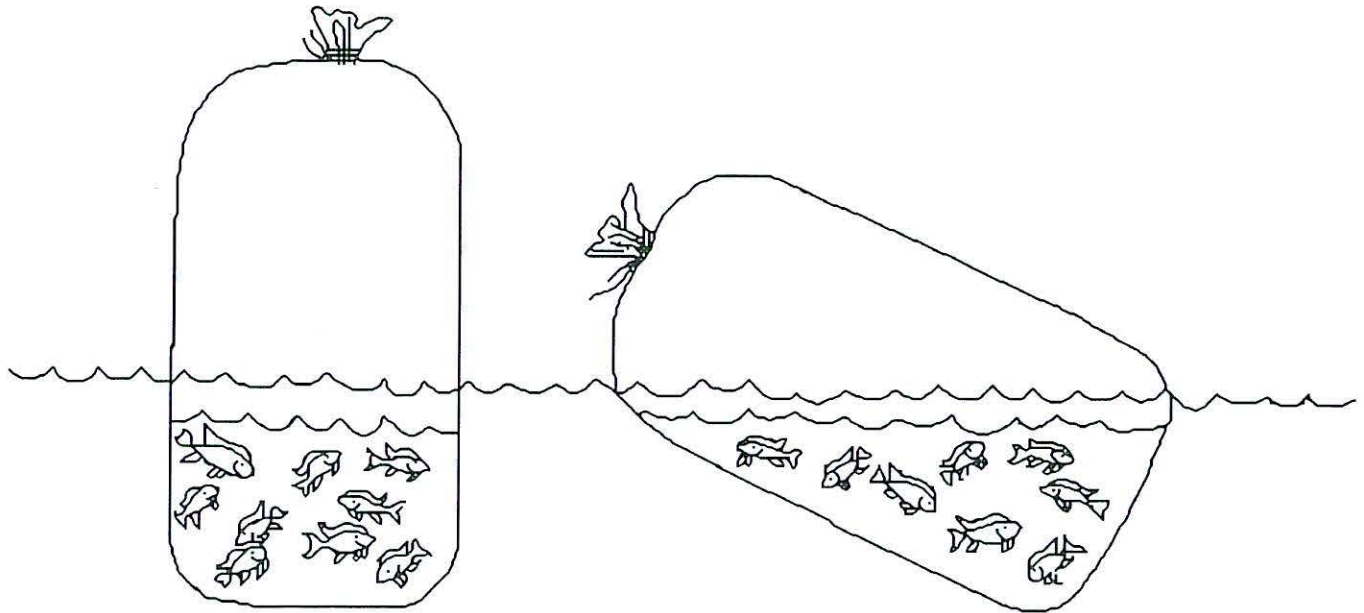

Figure 24: Float transport bags where the fish will be stocked.

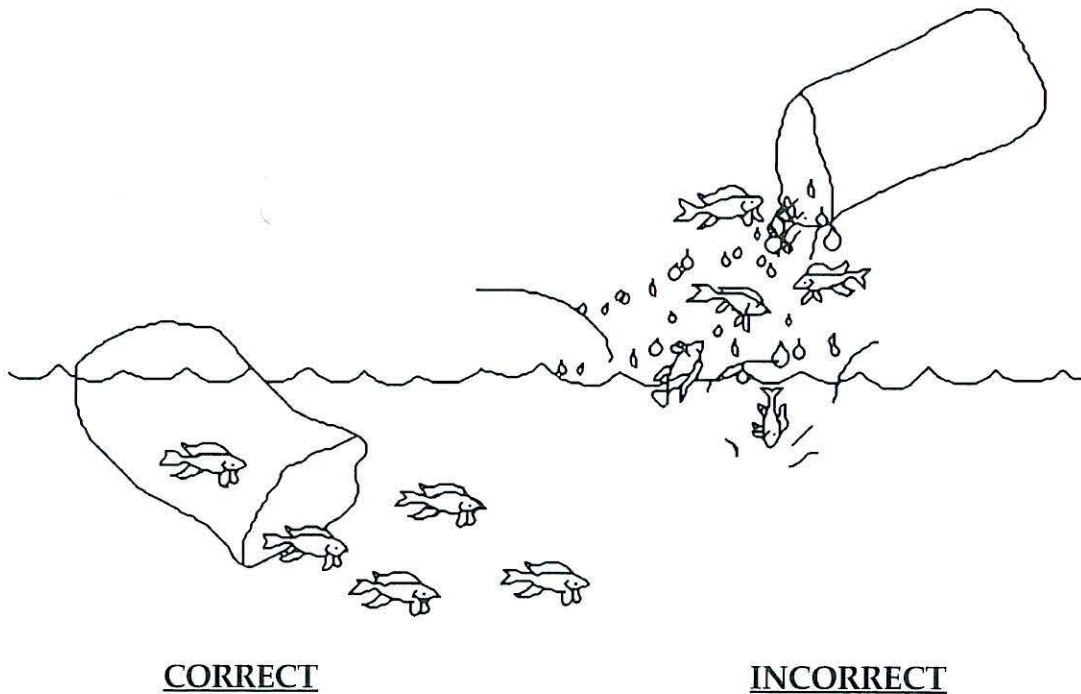

Figure 25: Immerse the bag and allow fish to swim out. This is better than scooping them out with a net. DO NOT dump or pour the fish in.

Summary

1. Stop feeding fish 24 to 48 hours prior to transporting them.
2. Prepare all transport containers, oxygen and other equipment.
3. Harvest fish during the coolest part of the day. (Very early morning).
4. Quickly, but gently, load harvested fish into a transport container.
 - DO NOT OVERSTOCK.
 - USE BOTTLED OXYGEN IF POSSIBLE.
5. Insulate from heat during transport.
6. Transport fish on the fastest, smoothest means of transportation available.
7. Upon arrival at their new home, adjust fish to their new surroundings slowly by gradually exchanging water to avoid temperature and ionic shock.

GLOSSARY OF TERMS

aeration - the process of adding pure oxygen or air into water for the purpose of increasing the dissolved oxygen content.

agitation - the process of increasing the amount of oxygen in water by stirring, pouring, shaking or some other mechanical means.

brood fish/stock - sexually mature fish selected for reproduction.

diffused oxygen - oxygen that is introduced into water as finely diffused bubbles from a tank of pure oxygen.

fry/post larvae - recently hatched fish which weigh less than 1 g or measure less than 2.5 cm in total length.

hydrogen peroxide - an antiseptic, commonly available in pharmacies, which may be used to produce oxygen for fish transport.

ionic shock - a condition resulting when fish are transported and, without acclimation, stocked into new water having chemical properties differing greatly from the transport water.

larvae - recently hatched fish which are still too young to feed.

pure bottled oxygen - high quality oxygen used by hospitals and welders that is contained in a tank or bottle and is also used in fish transport.

sac fry - the stage in a fish's life cycle at which it has a yolk sac.

spawning - the act of depositing eggs and producing young.

Funding for this technical series was provided by the United States Agency for International Development. Communications regarding this and other technical brochures on water harvesting and aquaculture should be sent to:

Alex Bocek, Editor
International Center for Aquaculture and Aquatic Environments
Swingle Hall
Auburn University, Alabama 36849-5419 USA

Suzanne Gray, Illustrator

Information in this manual is available to all persons regardless of race, color, sex or national origin.